

<b>4K</b>	<b>Commercial Industrial</b>	<b>X2804A X2804AI</b>	<b>512 x 8 Bit</b>
<b>Electrically Erasable PROM</b>			

### FEATURES

- **Simple Byte Write Operation**
  - Internally Latched Address and Data
  - Self Timed Write
  - Noise Protected  $\overline{WE}$  Pin
- **Reliable N-Channel Floating Gate MOS Technology**
- **Single 5V Supply**
- **High Reliability**
  - Endurance: 10,000 Writes Per Byte
  - Data Retention: 100 Years
- **Byte Write Time: 10 ms Max.**
- **Fast Access Time: 250 ns Max.**
- **Low Power Dissipation**
  - Active Current: 80 mA Max.
  - Standby Current: 50 mA Max.

### DESCRIPTION

The Xicor X2804A is a 512 x 8 E<sup>2</sup>PROM, fabricated with the same reliable N-channel floating gate MOS technology used in all Xicor 5V programmable nonvolatile memories. The X2804A is compatible with the JEDEC approved pinout for byte-wide memories.

Xicor E<sup>2</sup>PROMs are designed and tested for applications requiring extended endurance and data retention. Endurance is specified as 10,000 cycles per byte minimum and data retention is specified as 100 years minimum. Refer to Xicor reliability reports RR-520 and RR-515 for details of endurance and data retention characteristics.



### PIN CONFIGURATION

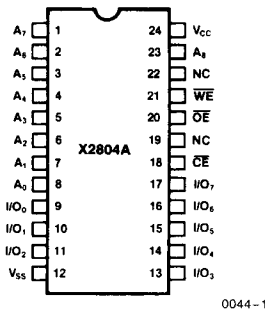

### PIN NAMES

$A_0-A_8$	Address Inputs
$I/O_0-I/O_7$	Data Input/Output
$\overline{WE}$	Write Enable
$\overline{CE}$	Chip Enable
$\overline{OE}$	Output Enable
$V_{CC}$	+5V
$V_{SS}$	Ground
NC	No Connect

### FUNCTIONAL DIAGRAM

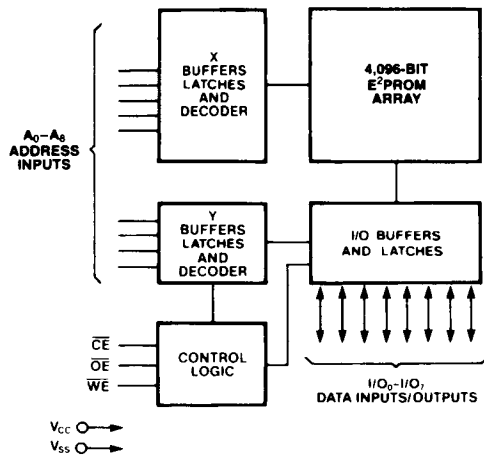

0044-2

# X2804A, X2804AI

## ABSOLUTE MAXIMUM RATINGS\*

Temperature Under Bias	
X2804A	-10°C to +85°C
X2804AI	-65°C to +135°C
Storage Temperature	-65°C to +150°C
Voltage on any Pin with Respect to Ground	-1.0V to +7V
D.C. Output Current	5 mA
Lead Temperature (Soldering, 10 Seconds)	300°C

## \*COMMENT

Stresses above those listed under "Absolute Maximum Ratings" may cause permanent damage to the device. This is a stress rating only and the functional operation of the device at these or any other conditions above those indicated in the operational sections of this specification is not implied. Exposure to absolute maximum rating conditions for extended periods may affect device reliability.

## D.C. OPERATING CHARACTERISTICS

X2804A  $T_A = 0^\circ\text{C}$  to  $+70^\circ\text{C}$ ,  $V_{CC} = +5\text{V} \pm 5\%$ , unless otherwise specified.

X2804AI  $T_A = -40^\circ\text{C}$  to  $+85^\circ\text{C}$ ,  $V_{CC} = +5\text{V} \pm 10\%$ , unless otherwise specified.

Symbol	Parameter	X2804A Limits		X2804AI Limits		Units	Test Conditions
		Min.	Max.	Min.	Max.		
$I_{CC}$	$V_{CC}$ Current (Active)		80		100	mA	$\overline{CE} = \overline{OE} = V_{IL}$ All I/O's = Open Other Inputs = $V_{CC}$
$I_{SB}$	$V_{CC}$ Current (Standby)		50		60	mA	$\overline{CE} = V_{IH}$ , $\overline{OE} = V_{IL}$ All I/O's = Open Other Inputs = $V_{CC}$
$I_{LI}$	Input Leakage Current		10		10	$\mu\text{A}$	$V_{IN} = \text{GND to } V_{CC}$
$I_{LO}$	Output Leakage Current		10		10	$\mu\text{A}$	$V_{OUT} = \text{GND to } V_{CC}$
$V_{IL}^{(2)}$	Input Low Voltage	-1.0	0.8	-1.0	0.8	V	
$V_{IH}^{(2)}$	Input High Voltage	2.0	$V_{CC} + 0.5$	2.2	$V_{CC} + 1.0$	V	
$V_{OL}$	Output Low Voltage		0.4		0.4	V	$I_{OL} = 2.1 \text{ mA}$
$V_{OH}$	Output High Voltage	2.4		2.4		V	$I_{OH} = -400 \mu\text{A}$

**CAPACITANCE**  $T_A = 25^\circ\text{C}$ ,  $f = 1.0 \text{ MHz}$ ,  $V_{CC} = 5\text{V}$

Symbol	Test	Max.	Units	Conditions
$C_{I/O}^{(1)}$	Input/Output Capacitance	10	pF	$V_{I/O} = 0\text{V}$
$C_{IN}^{(1)}$	Input Capacitance	6	pF	$V_{IN} = 0\text{V}$

## A.C. CONDITIONS OF TEST

Input Pulse Levels	0V to 3.0V
Input Rise and Fall Times	10 ns
Input and Output Timing Levels	1.5V
Output Load	1 TTL Gate and $C_L = 100 \text{ pF}$

## MODE SELECTION

CE	OE	WE	Mode	I/O	Power
L	L	H	Read	$D_{OUT}$	Active
L	H	L	Write	$D_{IN}$	Active
H	X	X	Standby and Write Inhibit	High Z	Standby
X	L	X	Write Inhibit	—	—
X	X	H	Write Inhibit	—	—

**Notes:** (1) This parameter is periodically sampled and not 100% tested.

(2)  $V_{IL}$  min. and  $V_{IH}$  max. are for reference only and are not tested.

# X2804A, X2804AI

## ENDURANCE AND DATA RETENTION

Parameter	Min.	Max.	Units	Conditions
Endurance	10,000		Cycles/Byte	Xicor Reliability Report RR-520
Data Retention	100		Years	Xicor Reliability Report RR-515

## A.C. CHARACTERISTICS

X2804A  $T_A = 0^\circ\text{C}$  to  $+70^\circ\text{C}$ ,  $V_{CC} = +5\text{V} \pm 5\%$ , unless otherwise specified.

X2804AI  $T_A = -40^\circ\text{C}$  to  $+85^\circ\text{C}$ ,  $V_{CC} = +5\text{V} \pm 10\%$ , unless otherwise specified.

## Read Cycle Limits

Symbol	Parameter	X2804A-25 X2804AI-25		X2804A X2804AI		X2804A-35 X2804AI-35		X2804A-45 X2804AI-45		Units
		Min.	Max.	Min.	Max.	Min.	Max.	Min.	Max.	
$t_{RC}$	Read Cycle Time	250		300		350		450		ns
$t_{CE}$	Chip Enable Access Time		250		300		350		450	ns
$t_{AA}$	Address Access Time		250		300		350		450	ns
$t_{OE}$	Output Enable Access Time		120		120		135		150	ns
$t_{LZ}$	Chip Enable to Output in Low Z	10		10		10		10		ns
$t_{HZ}^{(3)}$	Chip Disable to Output in High Z	10	100	10	100	10	100	10	100	ns
$t_{OLZ}^{(3)}$	Output Enable to Output in Low Z	50		50		50		50		ns
$t_{OHZ}^{(3)}$	Output Disable to Output in High Z	10	100	10	100	10	100	10	100	ns
$t_{OH}^{(3)}$	Output Hold from Address Change	20		20		20		20		ns

3

## Read Cycle

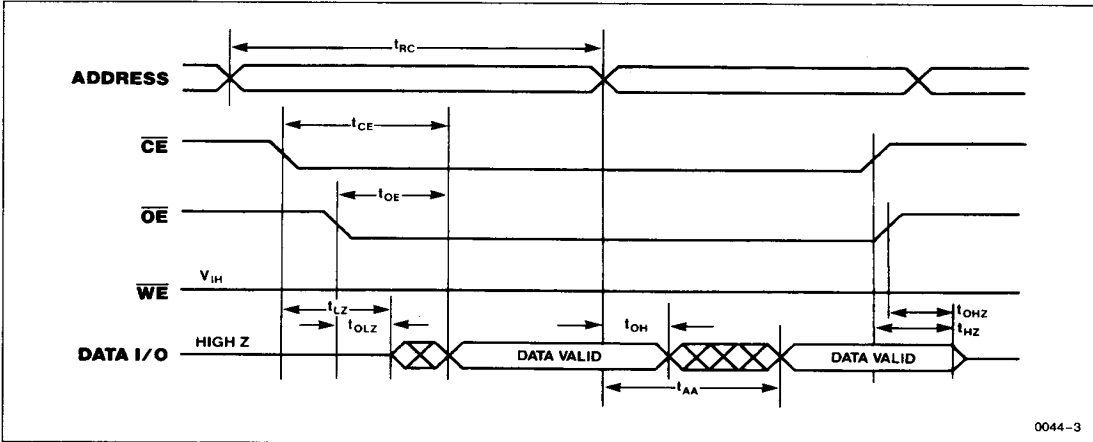

Note: (3)  $t_{HZ}$  max. and  $t_{OHZ}$  max. are measured from the point when  $\overline{CE}$  or  $\overline{OE}$  return high (whichever occurs first) to the time when the outputs are no longer driven.  $t_{HZ}$  min.,  $t_{OHZ}$  min.,  $t_{LZ}$  min. and  $t_{OLZ}$  min. are periodically sampled and are not 100% tested.

# X2804A, X2804AI

## Write Cycle Limits

Symbol	Parameter	X2804A-25 X2804AI-25		X2804A X2804AI		X2804A-35 X2804AI-35		X2804A-45 X2804AI-45		Units
		Min.	Max.	Min.	Max.	Min.	Max.	Min.	Max.	
$t_{WC}^{(7)}$	Write Cycle Time		10		10		10		10	ms
$t_{AS}$	Address Setup Time	10		10		10		10		ns
$t_{AH}$	Address Hold Time	120		120		150		150		ns
$t_{CS}$	Write Setup Time	0		0		0		0		ns
$t_{CH}$	Write Hold Time	0		0		0		0		ns
$t_{CW}$	Chip Enable to End of Write Input	150		150		175		230		ns
$t_{OES}$	Output Enable Setup Time	10		10		10		10		ns
$t_{OEH}$	Output Enable Hold Time	10		10		10		10		ns
$t_{WP}$	Write Pulse Width	150		150		175		230		ns
$t_{WPH}$	Write Control Recovery	50		50		50		50		ns
$t_{DV}$	Data Valid Time		1		1		1		1	$\mu$ s
$t_{DS}$	Data Setup Time	120		135		175		230		ns
$t_{DH}$	Data Hold Time	15		15		20		30		ns

## WE Controlled Write Cycle

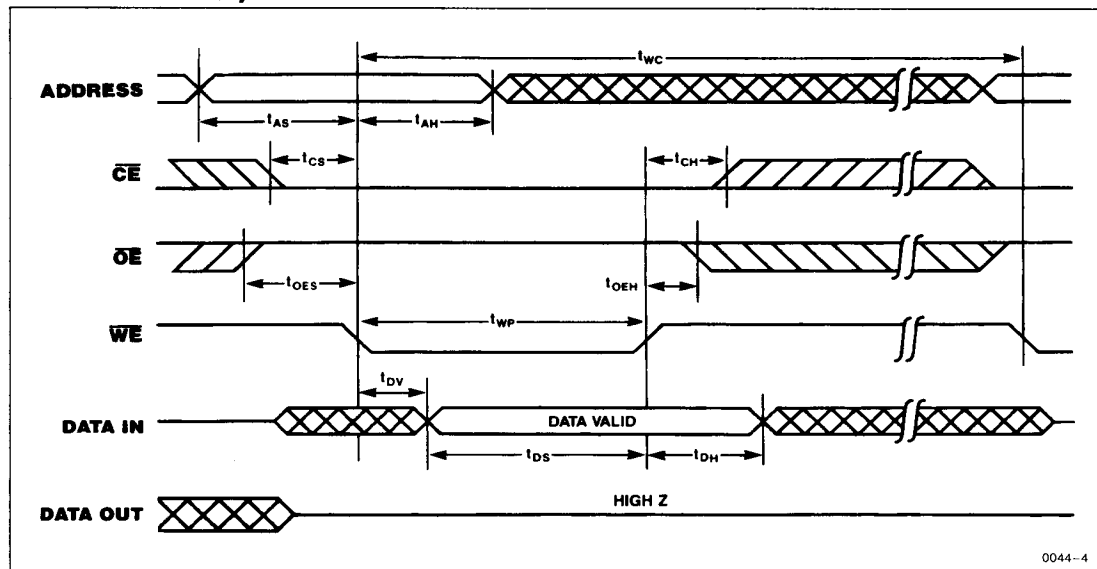

Note: (7)  $t_{WC}$  is the minimum cycle time to be allowed from the system perspective unless polling techniques are used. It is the maximum time the device requires to automatically complete the internal write operation.

# X2804A, X2804AI

## $\overline{CE}$ Controlled Write Cycle

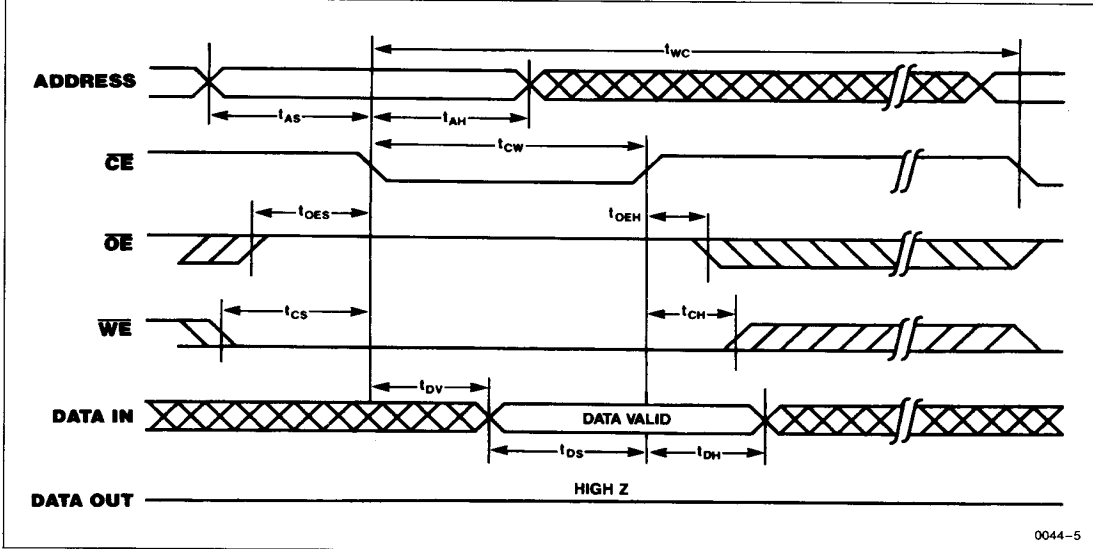

3

# X2804A, X2804AI

---

## PIN DESCRIPTIONS

### Addresses ( $A_0$ – $A_8$ )

The Address inputs select an 8-bit memory location during a read or write operation.

### Chip Enable ( $\overline{CE}$ )

The Chip Enable input must be LOW to enable all read/write operations. When  $\overline{CE}$  is HIGH, power consumption is reduced.

### Output Enable ( $\overline{OE}$ )

The Output Enable input controls the data output buffers and is used to initiate read operations.

### Data In/Data Out ( $I/O_0$ – $I/O_7$ )

Data is written to or read from the X2804A through the I/O pins.

### Write Enable ( $\overline{WE}$ )

The Write Enable input controls the writing of data to the X2804A.

## DEVICE OPERATION

### Read

Read operations are initiated by both  $\overline{OE}$  and  $\overline{CE}$  LOW. The read operation is terminated by either  $\overline{CE}$  or  $\overline{OE}$  returning HIGH. This 2-line control architecture eliminates bus contention in a system environment. The data bus will be in a high impedance state when either  $\overline{OE}$  or  $\overline{CE}$  is HIGH.

### Write

Write operations are initiated when both  $\overline{CE}$  and  $\overline{WE}$  are LOW and  $\overline{OE}$  is HIGH. The X2804A supports both

a  $\overline{CE}$  and  $\overline{WE}$  controlled write cycle. That is, the address is latched by the falling edge of either  $\overline{CE}$  or  $\overline{WE}$ , whichever occurs last. Similarly, the data is latched internally by the rising edge of either  $\overline{CE}$  or  $\overline{WE}$ , whichever occurs first.

A byte write operation, once initiated, will automatically continue to completion, typically within 5 ms. In order to take advantage of the typical write time as opposed to the maximum specified time, the user can poll the X2804A. The I/O pins are placed in the high impedance state during the internal programming cycle. Once the internal cycle is complete, the X2804A may be accessed without any limitations. Therefore, the host can poll an address with known data (preferably with zeroes), as soon as a compare is true, the X2804A is ready for another write cycle.

## WRITE PROTECTION

There are three features that protect the nonvolatile data from inadvertent writes.

- Noise Protection—A  $\overline{WE}$  pulse typically less than 20 ns will not initiate a write cycle.
- $V_{CC}$  Sense—All functions are inhibited when  $V_{CC}$  is  $\leq 3V$ , typically.
- Write Inhibit—Holding either  $\overline{OE}$  LOW,  $\overline{WE}$  HIGH or  $\overline{CE}$  HIGH during power-on and power-off, will inhibit inadvertent writes.

# X2804A, X2804AI

## SYSTEM CONSIDERATIONS

Because the X2804A is frequently used in large memory arrays it is provided with a two line control architecture for both read and write operations. Proper usage can provide the lowest possible power dissipation and eliminate the possibility of contention where multiple I/O pins share the same bus.

To gain the most benefit it is recommended that  $\overline{CE}$  be decoded from the address bus and be used as the primary device selection input. Both  $\overline{OE}$  and  $\overline{WE}$  would then be common among all devices in the array. For a read operation this assures that all deselected devices are in their standby mode and that only the selected device(s) is outputting data on the bus.





Because the X2804A has two power modes, standby and active, proper decoupling of the memory array is

of prime concern. Enabling  $\overline{CE}$  will cause transient current spikes. The magnitude of these spikes is dependent on the output capacitive loading of the I/Os. Therefore, the larger the array sharing a common bus, the larger the transient spikes. The voltage peaks associated with the current transients can be suppressed by the proper selection and placement of decoupling capacitors. As a minimum, it is recommended that a 0.1  $\mu\text{F}$  high frequency ceramic capacitor be used between  $V_{CC}$  and GND at each device. Depending on the size of the array, the value of the capacitor may have to be larger.

In addition, it is recommended that a 4.7  $\mu\text{F}$  electrolytic bulk capacitor be placed between  $V_{CC}$  and GND for each eight devices employed in the array. This bulk capacitor is employed to overcome the voltage droop caused by the inductive effects of the PC board traces.

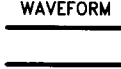
3

## SYMBOL TABLE

WAVEFORM	INPUTS	OUTPUTS
	Must be steady	Will be steady
	May change from Low to High	Will change from Low to High
	May change from High to Low	Will change from High to Low
	Don't Care : Changes Allowed	Changing : State Not Known
	N/A	Center Line is High Impedance

# X2804A, X2804AI

**Normalized Active Supply Current vs. Ambient Temperature**

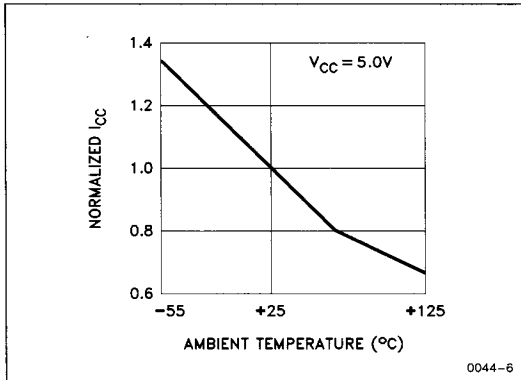

**Normalized Standby Supply Current vs. Ambient Temperature**

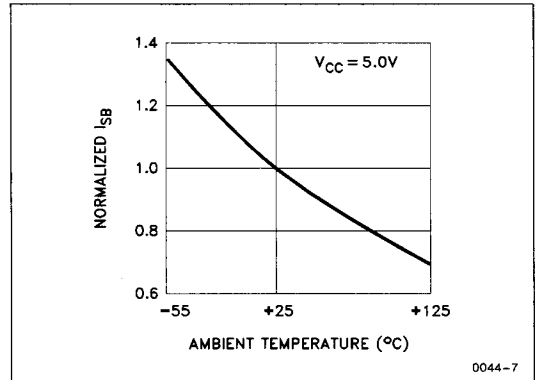

**Normalized Access Time vs. Ambient Temperature**

